

High operating force type for automotive needs with 1.4mm height



TACT Switch™

Sharp Feeling

Soft Feeling

Snap-In Type

Surface Mount Type

Radial Type

■ Typical Specifications

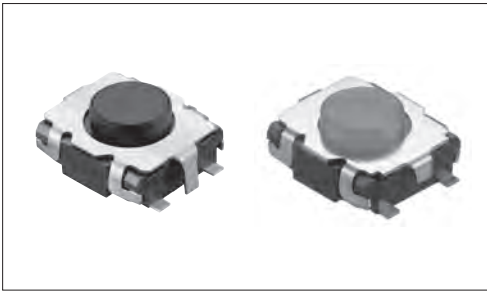

Items	Specifications
Rating (max.)	50mA 12V DC
Rating (min.)	10 μ A 1V DC
Initial contact resistance	100m Ω max.
Travel (mm)	0.12

■ Product Line

Top push type

Product No.	Operating force	Operating direction	Operating life (5mA 5V DC)	Stem color	Minimum order unit (pcs.)	
					Japan	Export
SKSGACE010	1.6N	Top push	200,000 cycles	Natural	12,000	12,000
SKSGAFE010	2.8N			Black		
SKSGAAE010	4N					

With ground terminal type

Product No.	Operating force	Operating direction	Operating life (5mA 5V DC)	Stem color	Minimum order unit (pcs.)	
					Japan	Export
SKSGPCE010	1.6N	Top push	200,000 cycles	Natural	12,000	12,000
SKSGPGE010	2.8N			Black		
SKSGPAE010	4N					

■ Packing Specifications

Taping

Number of packages (pcs.)			Tape width (mm)	Export package measurements (mm)
1 reel	1 case / Japan	1 case / export packing		
12,000	120,000	120,000	12	395×395×205

Note

For reels of 330mm diameter, please inquire.

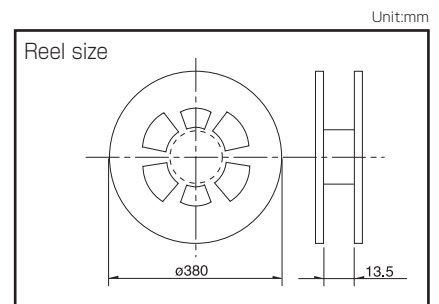

Refer to P.235 for soldering conditions.





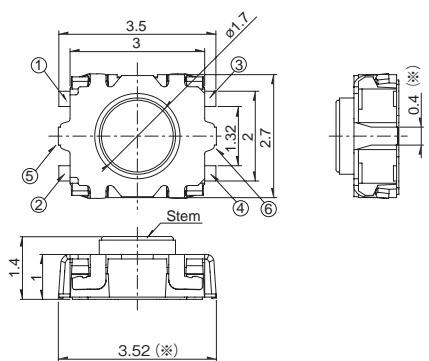
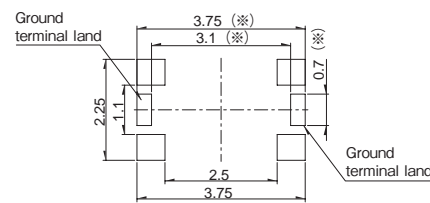



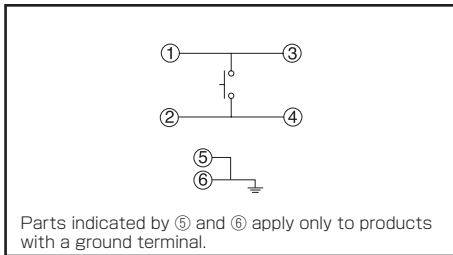









■ Dimensions

Unit:mm

Style	PC board land dimensions (Viewed from switch mounting face)
 <p>Parts indicated by ⑤, ⑥ and ※ apply only to products with a ground terminal.</p>	 <p>Parts indicated by a ※ apply only to products with a ground terminal.</p>

■ Circuit Diagram



Type		Sharp Feeling Type										
		Surface Mount										
Series		SKSD	SKRN	SKTA	SKSV	SKSW	SKTK	SKSG				
Photo												
Features		Double action		Compact size Low-profile			Long life	High operation force Compact size				
Water-proof		—	—	●	●	●	●	—				
Dustproof		—	—	●	●	●	●	—				
IP standard		—	—	67 equivalent	67 equivalent	67 equivalent 68 equivalent in some cases	67 equivalent	—				
Operating direction	Top push	●	●	●	●	●	●	●				
	Side push	—	—	—	—	—	—	—				
Dimensions (mm)	W	4.1	□6	2.6	2.8	3	5.9	3				
	D	3.9		1.6	1.9	2	4	2.7				
	H	0.6	0.9	0.53	0.5	0.6	0.78	1.4				
Operation force coverage	1N max.	See the relevant pages for respective product descriptions										
	1N to 2N											
	2N to 3N											
	3N to 4N											
4N to 5N												
Travel (mm)					See the relevant pages for respective product descriptions		0.11	0.12	See the relevant pages for respective product descriptions		0.25	0.12
Ground terminal					●	●	—	—	—	—	○	
Operating temperature range					-40°C to +90°C		-30°C to +85°C				-40°C to +85°C	
Automotive use		—	—	—	—	—	—	●				
Life Cycle												
Electrical performance	Rating (max.) (Resistive load)	50mA 12V DC										
	Rating (min.) (Resistive load)	10μA 1V DC										
	Insulation resistance	100MΩ min. 100V DC 1min.										
	Voltage proof	100V AC 1min.	250V AC 1min.	100V AC 1min.								
Durability	Vibration	10 to 55 to 10Hz/min., the amplitude is 1.5mm for all the frequencies, in the 3 direction of X, Y and Z for 2 hours respectively										
	Lifetime	Shall be in accordance with individual specifications.										
Environmental performance	Cold	-40°C 96h										
	Dry heat	90°C 96h										
	Damp heat	60°C, 90 to 95%RH 96h										
Page		195	196	197	198	199	201	202				

W : Width. The most outer dimension excluding terminal portion.

D : Depth. The most outer dimension excluding terminal portion.

H : Height. The minimum dimension if there are variances.

TACT Switch™ Soldering Conditions	235
TACT Switch™ Cautions	236

Notes

- The automotive operating temperature range to be individually discussed upon request.
- Indicates applicability to all products in the series, while ○ indicates applicability to some products in the series.

Condition for Reflow

Available for Surface Mount Type.

Temperature profile

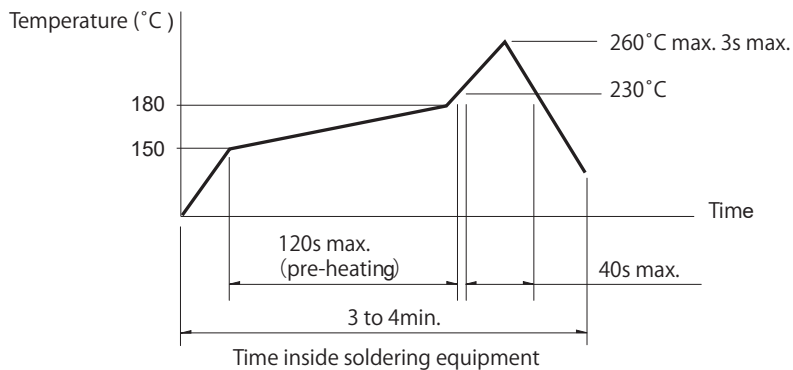

Notes

1. Please confirm the specifications of our product for the detailed condition.
2. Soldering conditions differ depending on reflow soldering machines.
Prior verification of soldering condition is highly recommended.

Conditions for Auto-dip

Available for Snap-in Type and Radial Type.

Items	Condition
Flux built-up	Mounting surface should not be exposed to flux
Preheating temperature	Ambient temperature of the soldered surface of PC board. 100°C max.
Preheating time	60s max.
Soldering temperature	260°C max.
Duration of immersion	5s max.
Number of soldering	2times max.

SKHH Series

Items	Condition
Flux built-up	Mounting surface should not be exposed to flux
Preheating temperature	Ambient temperature of the soldered surface of PC board. 110°C max.
Preheating time	60s max.
Soldering temperature	260°C max.
Duration of immersion	5s max.
Number of soldering	2times max.

SKHL Top Push Type, SKQJ Series

Items	Condition
Flux built-up	Mounting surface should not be exposed to flux
Preheating temperature	Ambient temperature of the soldered surface of PC board. 100°C max.
Preheating time	45s max.
Soldering temperature	255°C max.
Duration of immersion	5s max.
Number of soldering	2times max.

Notes

1. Prevent flux penetration from the top side of the TACT Switch™.
2. Switch terminals and a PC board should not be coated with flux prior to soldering.
3. The second soldering should be done after the switch is stable with normal temperature.
4. Use the flux with a specific gravity of min 0.81.
(EC-19S-8 by TAMURA CORPORATION, or equivalents.)

Manual Soldering

Items	Condition
Soldering temperature	350°C max.
Duration of soldering	3s max.
Capacity of soldering iron	60W max.

SKHH, SKHW Series

Items	Condition
Soldering temperature	360°C max.
Duration of soldering	3s max.
Capacity of soldering iron	60W max.

SKTD, SKTG, SKQJ, SKSN Series

Items	Condition
Soldering temperature	350°C max.
Duration of soldering	3s max.
Capacity of soldering iron	20W max.