

Switch contributing to high-density mounting,  
available with top or side push operation

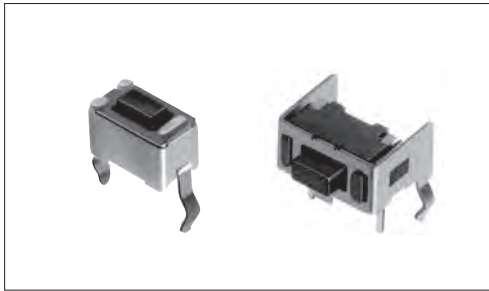

### Typical Specifications



Items	Specifications
Rating (max.)	50mA 12V DC
Rating (min.)	10 $\mu$ A 1V DC
Initial contact resistance	500m $\Omega$ max.
Travel (mm)	0.25

### Product Line

Top push type

Product No.	Operating force	Operating direction	Operating life (5mA 5V DC)	Stem color	Height	Minimum order unit (pcs.)		Drawing No.
						Japan	Export	
<b>SKHLAA010</b>	0.98N	Top push	50,000 cycles	Black	h=4.3mm	1,000	1,000	1
<b>SKHLACA010</b>	1.57N			Dark gray				
<b>SKHLAJA010</b>	2.55N		30,000 cycles	Red				
<b>SKHLABA010</b>	0.98N		50,000 cycles	Black	h=5mm			
<b>SKHLADA010</b>	1.57N			Dark gray				
<b>SKHLAKA010</b>	2.55N		30,000 cycles	Red				

Side push type

Product No.	Operating force	Operating direction	Operating life (5mA 5V DC)	Stem color	Terminal length	Minimum order unit (pcs.)		Drawing No.
						Japan	Export	
<b>SKHLLA010</b>	0.98N	Side push	50,000 cycles	Black	$\phi$ =3.5mm (PC board t : 1.6)	1,000	1,000	2
<b>SKHLLBA010</b>	1.57N			Dark gray				
<b>SKHLLFA010</b>	2.55N		30,000 cycles	Red				
<b>SKHLLCA010</b>	0.98N		50,000 cycles	Black	$\phi$ =2.5mm (PC board t : 1.0)			
<b>SKHLLDA010</b>	1.57N			Dark gray				

### Packing Specifications

Bulk

Number of packages (pcs.)		Export package measurements (mm)
1 case / Japan	1 case / export packing	
10,000	30,000	309×476×347

Refer to P.235 for soldering conditions.

# SKHL 6×3.5mm Compact (Snap-in Type)

TACT Switch™

Sharp Feeling

Soft Feeling



Snap-in Type

Surface Mount Type

Radial Type

## ■ Dimensions

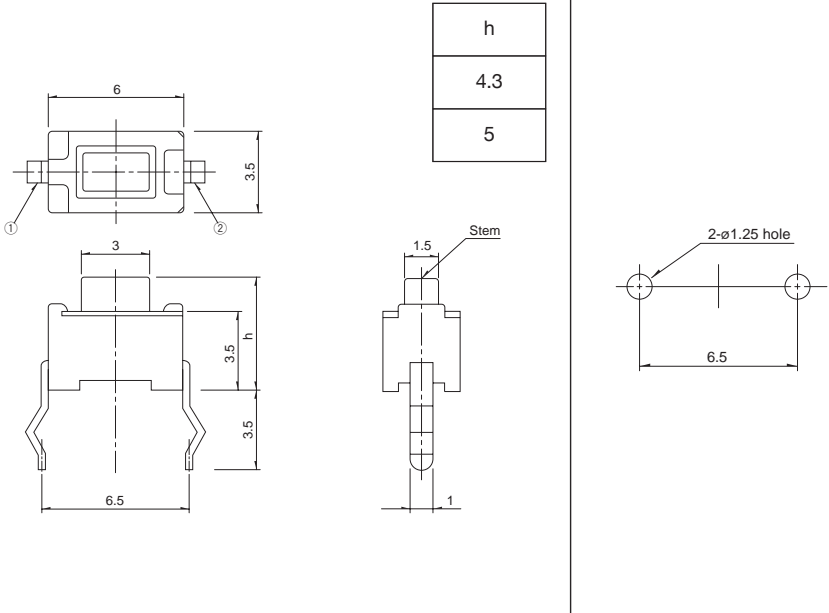
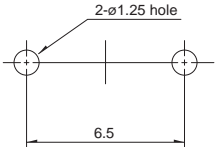
Unit:mm

No.	Photo	Style	PC board mounting hole dimensions (Viewed from switch mounting face)						
1		 <table border="1" data-bbox="975 376 1091 539"> <tr><td>h</td></tr> <tr><td>4.3</td></tr> <tr><td>5</td></tr> </table>	h	4.3	5				
h									
4.3									
5									
2		 <table border="1" data-bbox="863 1016 1091 1173"> <thead> <tr> <th>ø</th> <th>PWB</th> </tr> </thead> <tbody> <tr> <td>2.5</td> <td>t 1.0</td> </tr> <tr> <td>3.5</td> <td>t 1.6</td> </tr> </tbody> </table>	ø	PWB	2.5	t 1.0	3.5	t 1.6	
ø	PWB								
2.5	t 1.0								
3.5	t 1.6								

## ■ Circuit Diagram

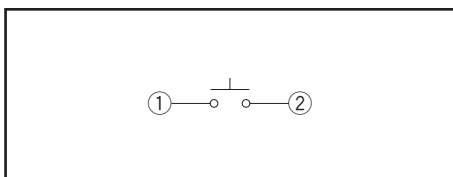

# TACT Switch™

## List of Varieties

TACT Switch™















Sharp Feeling

Soft Feeling

Snap-In Type

Surface Mount Type

Radial Type











Type		Sharp Feeling Type							
		Snap-in							
Series		SKHL	SKHH	SKHW	SKQJ	SKQB	SKQE	SKHC	
Photo									
Features		—	—	—	—	—	Long-life	—	
Water-proof		—	—	—	—	●	—	—	
Dustproof		—	—	●	●	●	●	—	
IP standard		—	—	—	—	—	—	—	
Operating direction	Top push	●	●	●	●	●	●	●	
	Side push	—	—	—	—	—	—	—	
Dimensions (mm)	W	6	□6		□6.6	□10	□12		
	D	3.5							
	H	4.3/5	See the relevant pages for respective product descriptions		4.3/5	5	5/13/23.2	See the relevant pages for respective product descriptions	
Operation force coverage	1N max.	↕	↕	↕	↕	↕	↕	↕	
	1N to 2N								
	2N to 3N								
	3N to 4N								
	4N to 5N								
Travel (mm)		0.25		0.3	0.25	0.3			
Ground terminal		—	○	—	—	—	—	—	
Operating temperature range		-40°C to +90°C			-20°C to +70°C		-40°C to +90°C		-40°C to +85°C
Automotive use		●	●	—	—	●	—	—	
Life Cycle									
Electrical performance	Rating (max.) (Resistive load)	50mA 12V DC							
	Rating (min.) (Resistive load)	10μA 1V DC							
	Insulation resistance	100MΩ min. 100V DC 1min.							
	Voltage proof	250V AC 1min.							
Durability	Vibration	10 to 55 to 10Hz/min., the amplitude is 1.5mm for all the frequencies, in the 3 direction of X, Y and Z for 2 hours respectively							
	Lifetime	Shall be in accordance with individual specifications.							
Environmental performance	Cold	-40°C 96h			-30°C 96h	-40°C 96h			
	Dry heat	90°C 96h			80°C 96h	90°C 96h			
	Damp heat	60°C, 90 to 95%RH 96h				60°C, 90 to 95%RH 1,000h	60°C, 90 to 95%RH 96h		
Page		173	175	179	180	182	184	186	

W : Width. The most outer dimension excluding terminal portion.  
D : Depth. The most outer dimension excluding terminal portion.  
H : Height. The minimum dimension if there are variances.

TACT Switch™ Soldering Conditions . . . . . 235  
TACT Switch™ Cautions . . . . . 236

### Notes

1. The automotive operating temperature range to be individually discussed upon request.
2. ● Indicates applicability to all products in the series, while ○ indicates applicability to some products in the series.

Type		Sharp Feeling Type				
		Snap-in				Radial
Series		SKHL	SKHH	SKQJ	SKQB	SKRC
Photo						
Features		—	—	—	—	Round terminal type
Water-proof		—	—	—	●	●
Dustproof		—	—	●	●	●
IP standard		—	—	—	—	—
Operating direction	Top push	—	—	—	—	●
	Side push	●	●	●	●	—
Dimensions (mm)	W	7.3	7.5	7.5	11.5	φ9
	D	7.22	7.85	7.85	11.9	
	H	4.3	7.4	7.3	11.3	
Operation force coverage	1N max.	↕	↕	↕	↕	↕
	1N to 2N					
	2N to 3N					
	3N to 4N					
	4N to 5N					
Travel (mm)		0.25			0.3	0.25
Ground terminal		●	●	—	—	—
Operating temperature range		-40°C to +90°C		-20°C to +70°C	-40°C to +95°C	-30°C to +85°C
Automotive use		●	●	—	●	—
Life Cycle						
Electrical performance	Rating (max.) (Resistive load)	50mA 12V DC				
	Rating (min.) (Resistive load)	10μA 1V DC				
	Insulation resistance	100MΩ min. 100V DC 1min.				
	Voltage proof	250V AC 1min.				
Durability	Vibration	10 to 55 to 10Hz/min., the amplitude is 1.5mm for all the frequencies, in the 3 direction of X, Y and Z for 2 hours respectively				
	Lifetime	Shall be in accordance with individual specifications.				
Environmental performance	Cold	-40°C 96h		-30°C 96h	-40°C 96h	
	Dry heat	90°C 96h		80°C 96h	90°C 96h	
	Damp heat	60°C, 90 to 95%RH 96h			60°C, 90 to 95%RH 1,000h	
Page		173	175	180	182	228

W : Width. The most outer dimension excluding terminal portion.  
 D : Depth. The most outer dimension excluding terminal portion.  
 H : Height. The minimum dimension if there are variances.

TACT Switch™ Soldering Conditions . . . . . 235  
 TACT Switch™ Cautions . . . . . 236

**Notes**

- The automotive operating temperature range to be individually discussed upon request.
- Indicates applicability to all products in the series.

## Condition for Reflow

Available for Surface Mount Type.

Temperature profile

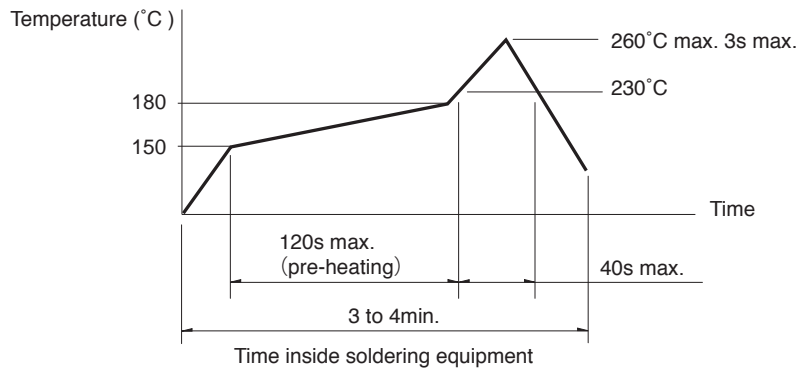

### Notes

1. Please confirm the specifications of our product for the detailed condition.
2. Soldering conditions differ depending on reflow soldering machines. Prior verification of soldering condition is highly recommended.

## Conditions for Auto-dip

Available for Snap-in Type and Radial Type.

Items	Condition
Flux built-up	Mounting surface should not be exposed to flux
Preheating temperature	Ambient temperature of the soldered surface of PC board. 100°C max.
Preheating time	60s max.
Soldering temperature	260°C max.
Duration of immersion	5s max.
Number of soldering	2times max.

### SKHH Series

Items	Condition
Flux built-up	Mounting surface should not be exposed to flux
Preheating temperature	Ambient temperature of the soldered surface of PC board. 110°C max.
Preheating time	60s max.
Soldering temperature	260°C max.
Duration of immersion	5s max.
Number of soldering	2times max.

### SKHL Top Push Type, SKQJ Series

Items	Condition
Flux built-up	Mounting surface should not be exposed to flux
Preheating temperature	Ambient temperature of the soldered surface of PC board. 100°C max.
Preheating time	45s max.
Soldering temperature	255°C max.
Duration of immersion	5s max.
Number of soldering	2times max.

### Notes

1. Prevent flux penetration from the top side of the TACT Switch™.
2. Switch terminals and a PC board should not be coated with flux prior to soldering.
3. The second soldering should be done after the switch is stable with normal temperature.
4. Use the flux with a specific gravity of min 0.81.  
(EC-19S-8 by TAMURA CORPORATION, or equivalents.)

## Manual Soldering

Items	Condition
Soldering temperature	350°C max.
Duration of soldering	3s max.
Capacity of soldering iron	60W max.

### SKHH, SKHW Series

Items	Condition
Soldering temperature	360°C max.
Duration of soldering	3s max.
Capacity of soldering iron	60W max.

### SKTD, SKTG, SKQJ, SKSN Series

Items	Condition
Soldering temperature	350°C max.
Duration of soldering	3s max.
Capacity of soldering iron	20W max.