

■ Typical Specifications

Items		Specifications	
		Standard	Medium-current
Rating (max.) / (min.) (Resistive load)		0.1A 30V DC 50μA 3V DC	1A 25V DC
Contact resistance (Initial / After operating life)		20mΩ max. / 40mΩ max.	
Operating forces	2-pole	2±1N	3±1.5N
	4-pole	2.5±1N	4±2N
Operating life	Without load	30,000 cycles	10,000 cycles
	With load	10,000 cycles (0.1A 30V DC)	5,000 cycles (1A 25V DC)

■ Product Line

Changeover timing	Travel (mm)	Total travel (mm)	Rating	Mounting method	Poles	Operation	Terminal type	Minimum order unit (pcs.)		Product No.
								Japan	Export	
Non shorting	2.5	3.5	Standard	PC board	2	Latching	Straight	250	1,250	SPUN191400
							Snap-in			SPUN191600
						Momentary	Straight			SPUN190900
							Snap-in			SPUN191000
			4		Latching	Straight	140	700	SPUN194700	
						Snap-in			SPUN194900	
			2		Latching	Straight	250	1,250	SPUN192600	
						Snap-in			SPUN192800	
4	Latching	Snap-in	140	700	SPUN19C400					

■ Packing Specifications

Bulk

Product No.	Number of packages (pcs.)		Export package measurements (mm)
	1 case / Japan	1 case / export packing	
SPUN190900, SPUN191000 SPUN191400, SPUN191600 SPUN192600, SPUN192800	250	1,250	400×270×290
SPUN194700, SPUN194900 SPUN19C400	140	700	

Detector

Slide

Push

Rotary

Power

Dual-in-line
Package Type

Horizontal
Type

Vertical
Type

SPUN 2.5mm-travel Large-sized Horizontal Type

Dimensions

Unit:mm

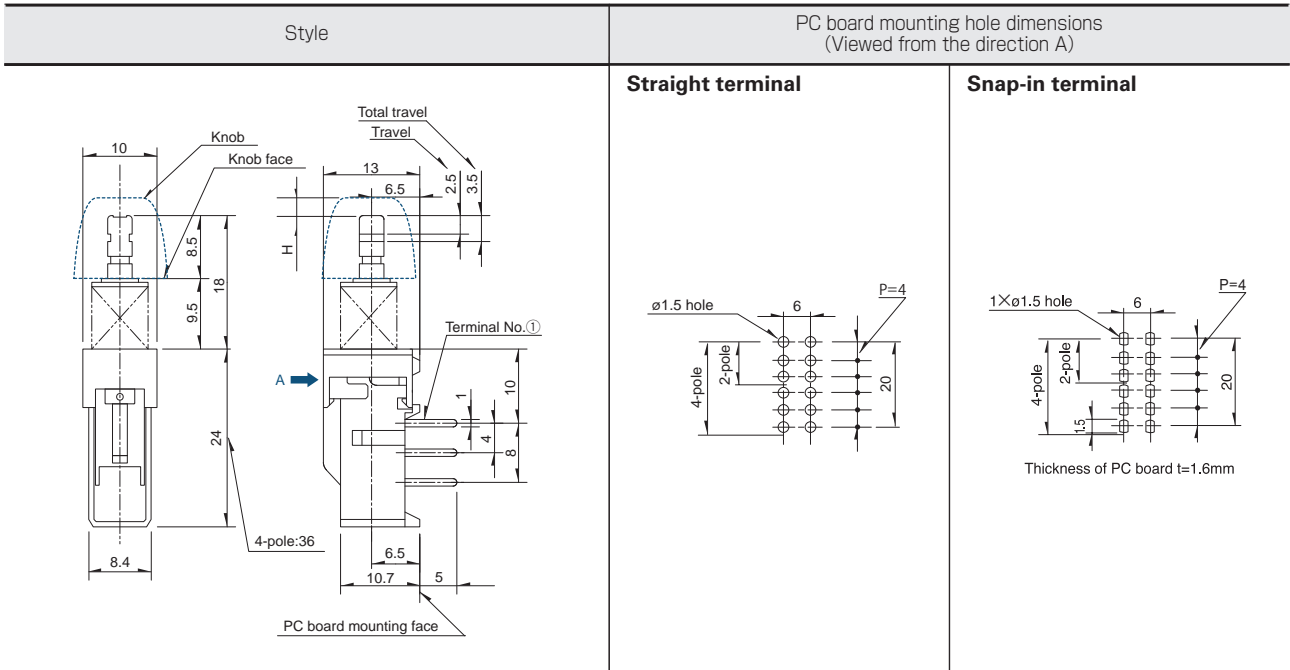

Actuator Configuration at Front Edge

Unit:mm

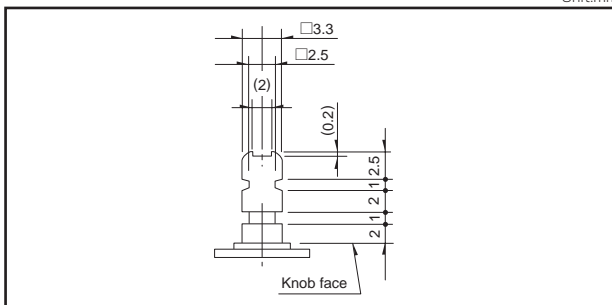

Circuit Diagram (Viewed from Direction A)

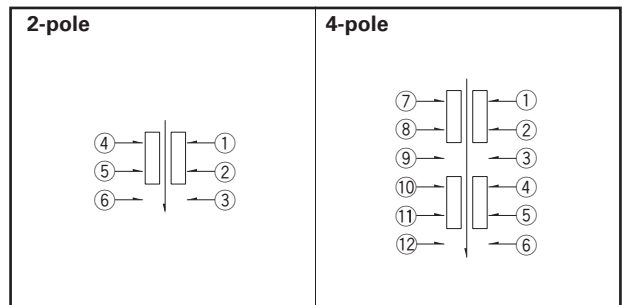

Knob Lineup

Unit:mm

Knob outline drawing	Model	Knob attachment height (H)
	Color:Black UE201011	2
	Color:Black UE200011	6





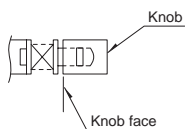





Notes

We recommend the use of adhesive to secure the knob when mounting onto switches.



Push Switches

List of Varieties

Series		Horizontal				
		SPPJ3	SPPJ2	SPUJ	SPUN	SPUN medium current
Photo						
Dimensions (mm)	W	5 or 6.6	7.2	7.5	10	
	D	12		15.2 22.7	24 36	
	H	8.3	9.6	8.8	13	
Travel (mm)		2.5		2	2.5	
Total travel (mm)		3.5		3	3.5	
Number of poles		1 2	2	2 4		
Operating temperature range		-40°C to +85°C		-10°C to +60°C		
Automotive use		●	●	—	—	—
Life cycle						
Rating (max.) (Resistive load)		0.2A 30V DC		0.1A 30V DC		1A 25V DC
Rating (min.) (Resistive load)		50μA 3V DC				—
Durability	Operating life without load	10,000 cycles 40mΩ max.			30,000 cycles 40mΩ max.	10,000 cycles 40mΩ max.
	Operating life with load (at max. rated load)	10,000 cycles 40mΩ max.			5,000 cycles 40mΩ max.	
Electrical performance	Initial contact resistance	20mΩ max.				
	Insulation resistance	100MΩ min. 500V DC				
	Voltage proof	500V AC for 1minute				
Mechanical performance	Terminal strength	5N for 1minute				
	Actuator strength	Operating direction	50N	30N	50N	
		Pulling direction	—	—	50N	
Environmental performance	Cold	-40°C 96h	-20°C 96h			
	Dry heat	85°C 96h				
	Damp heat	40°C, 90 to 95%RH 96h				
Page		111	113	115	117	

Push Switches Soldering Conditions	130
Push Switches Cautions	131

Note

● Indicates applicability to all products in the series.

Example of Reflow Soldering Condition

1. Heating method: Double heating method with infrared heater.
2. Temperature measurement: Thermocouple ϕ 0.1 to 0.2 CA (K) or CC (T) at soldering portion (copper foil surface). A heat resisting tape should be used for fixed measurement.
3. Temperature profile

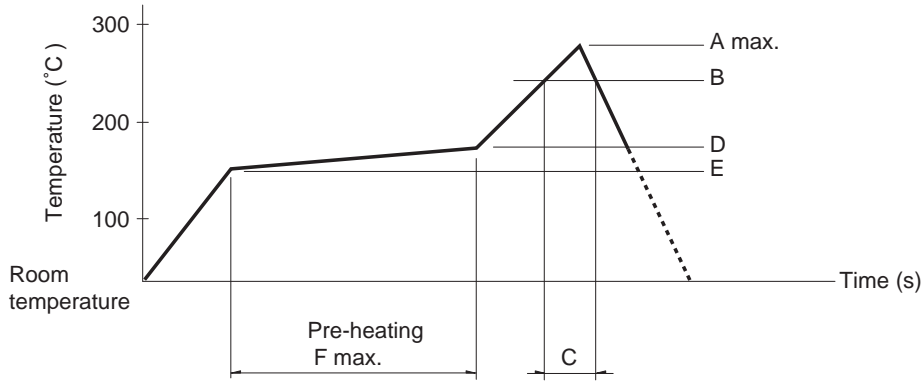

Series (Reflow type)	A (°C) 3s max.	B (°C)	C (s)	D (°C)	E (°C)	F (s)
SPEJ	260	230	40	180	150	120
SPEF						
SPEH						

Notes

1. The condition mentioned above is the temperature on the mounting surface of a PC board. There are cases where the PC board's temperature greatly differs from that of the switch, depending on the PC board's material, size, thickness, etc. The above-stated conditions shall also apply to switch surface temperatures.
2. Soldering conditions differ depending on reflow soldering machines. Prior verification of soldering condition is highly recommended.

Reference for Hand Soldering

Series	Soldering temperature	Soldering time
SPPJ3, SPPJ2, SPUN, SPUJ, SPPH4, SPPH1	350±10°C	3+1/0s
SPED2, SPED4	350±10°C	3±0.5s
SPEJ	350±10°C	4s max.
SPEF	350±5°C	3s max.
SPEH	350°C max.	3s max.

Reference for Dip Soldering

(For PC board terminal types)

Series	Items		Dip soldering	
	Preheating temperature	Preheating time	Soldering temperature	Duration of immersion
SPPJ3	100°C max.	60s max.	260±5°C	5±1s
SPUN	100°C max.	60s max.	260±5°C	10±1s
SPUJ, SPPH4	—	—	260±5°C	5±1s
SPPJ2, SPPH1, SPED2, SPED4, SPEF	—	—	260±5°C	10±1s