

Surface mount two-pole simultaneous changeover type achieving stable contact



Typical Specifications

Items		Specifications
Rating (max.)/(min.) (Resistive load)		50mA 18V DC / 50μA 5V DC
Contact resistance (Initial / After operating life)		75mΩ max. / 200mΩ max.
Operating force		1±0.5N
Operating life	Without load	300,000cycles
	With load	300,000cycle (50mA 18V DC)

Product Line

Poles	Positions	Changeover timing	Operating part shape	Terminal type	Minimum order unit (pcs)		Product No.
					Japan	Export	
2	2	Non shorting	Push	For PC board (Reflow)	300	2,400	SPVQC10201

Note

This unit cannot be used in water (IP67 rating, except for terminal).

Packing Specifications

Taping

Number of packages (pcs.)			Tape width (mm)	Export package measurements (mm)
1 reel	1 case /Japan	1 case /export packing		
300	1,200	2,400	32	403×403×360

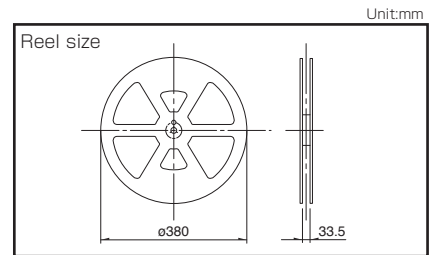

Dimensions

Style	Unit:mm
-------	---------

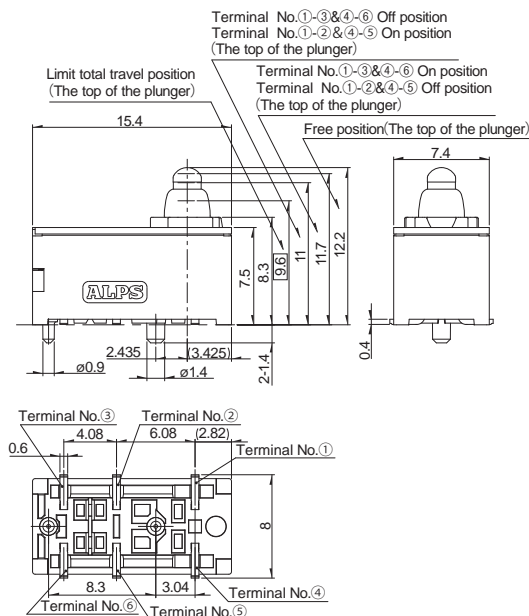



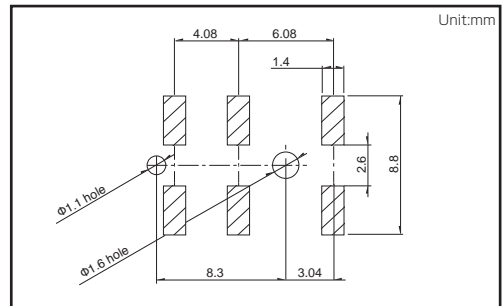

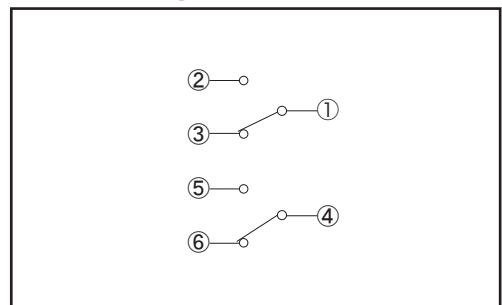

PC Board Mounting Hole and Land Dimensions

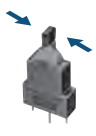

Circuit Diagram



Series		Water-proof Type		Fast Switching Type	
		SPVQA	SSCN	SPVQ9	SPVQC
Photo					
Operation type		Two-way			
Dimensions (mm)	W	15.2	13	15.4	15.4
	D	6.4	5	8.4	7.4
	H	7.95	15	7.5	
Operating temperature range		-40°C to +85°C			
Automotive use		●	●	●	●
Life cycle (availability)					
Poles / Positions		1/1 1/2	1/2	2/2	
Rating (max.) (Resistive load)		0.1A 12V DC		50mA 26V DC	50mA 18V DC
Rating (min.) (Resistive load)		50μA 5V DC	100μA 5V DC	50μA 5V DC	
Durability	Operating life without load	300,000cycles 1Ω max.	100,000cycles 1Ω max.	300,000cycles 200mΩ max.	—
	Operating life with load Rating (max.) (Resistive load)	300,000cycles 1Ω max.	100,000cycles 1Ω max.	300,000cycles 200mΩ max.	
Electrical performance	Initial contact resistance	500mΩ max.		75mΩ max.	
	Insulation resistance	100MΩ min. 500V DC			100MΩ min. 250V DC
	Voltage proof	500V AC for 1minute			250V AC for 1minute
Mechanical performance	Terminal strength	3N for 1minute			
	Actuator strength	20N	10N	20N	
Environmental performance	Cold	-40°C 500h			
	Dry heat	85°C 500h			
	Damp heat	60°C, 90 to 95% RH 500h			
Operation force		1±0.5N	2N max.	1±0.5N	
Page		62	65	66	67

Detector Switches Soldering Conditions	68
Detector Switches Cautions	69

Note

● Indicates applicability to all products in the series.

Detector Switches / Soldering Conditions

Example of Reflow Soldering Condition

1. Heating method: Double heating method with infrared heater.
2. Temperature measurement: Thermocouple $\phi 0.1$ to 0.2 CA (K) or CC (T) at soldering portion (copper foil surface).
A heat resisting tape should be used for fixed measurement.
3. Temperature profile

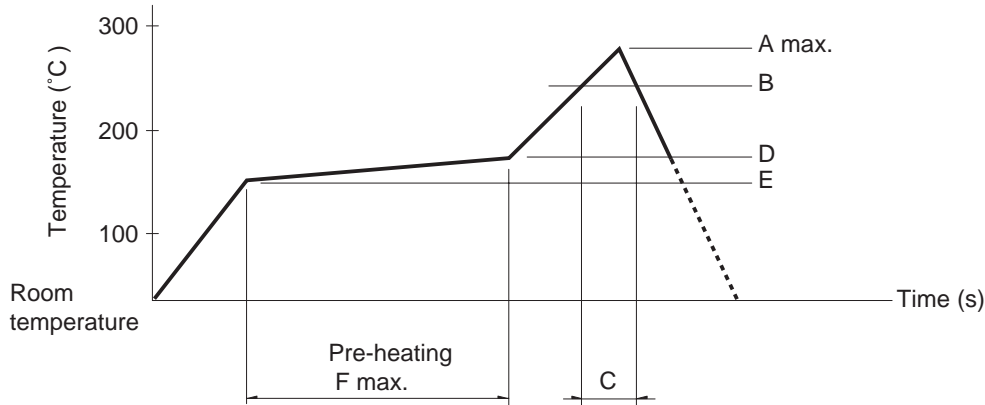

Series (Reflow type)	A (°C) 3s max.	B (°C)	C (s)	D (°C)	E (°C)	F (s)
SPPB	250	230	40	180	150	120
SPVE						
SPVL						
SPVM						
SPVN						
SPVR	260	230	40	180	150	120
SPVS						
SPVT						
SSCM	250	230	40	180	150	120
SSCQ						
SPVQC	250	230	40	180	150	120

Notes

1. The condition mentioned above is the temperature on the mounting surface of a PC board. There are cases where the PC board's temperature greatly differs from that of the switch, surface depending on the PC board's material, size, thickness, etc.
The above-stated conditions shall also apply to switch surface temperatures.
2. Soldering conditions differ depending on reflow soldering machines.
Prior verification of soldering condition is highly recommended.

Reference for Hand Soldering

Series	Soldering temperature	Soldering time
SPVS, SPVN, SPVT, SPVM, SPVR, SPVE, SSCQ, SSCM, SPVL, SSCT, SPVQC	350±5°C	3s max.
SPVQ3, SPVQ6, SPVQ7, SPVQ8, SPVQ9, SSCN, SPVQA	300±10°C	3 + 1 / 0s
SPPB (Reflow)	300±5°C	5s max.
SSCF, SPPB (For Lead, Dip)	350±10°C	3 + 1 / 0s

Reference for Dip Soldering

(For PC board terminal types)

Series	Items		Dip soldering	
	Preheating temperature	Preheating time	Soldering temperature	Duration of immersion
SSCT, SPVQ3, SPVQ6, SPVQ7, SPVQ8, SPVQ9, SPVQA	100±10°C	60s max.	260±5°C	5±1s
SPPW8, SPPB	100 °C max.	60s max.	255±5°C	5±1s
SSCF	—		260±5°C	5±1s