

Transient Voltage Suppressor

Version: A0 2021-10-09

Features

- IEC61000-4-2(ESD)±25KV(air),±18KV(Contact)
- IEC61000-4-4(EFT) 40A (5/50nS)
- IEC61000-4-5(Lightning) 4A (8/20uS)
- Working Voltage: 3.3V
- 4 Lines Protection
- Low leakage current
- Moisture sensitivity level: Level 1

Exterior

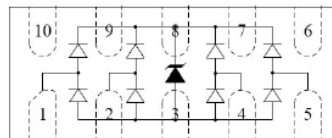

DFN2510

Application Information

- High Definition Multi-Media Interface (HDMI1.3/1.4/2.0)
- Digital Visual Interface (DVI)
- Display Port Interface
- Serial ATA
- PCI Express
- USB 1.1/2.0/3.0/3.1/OTG

Package (top view)



Agency Approvals

Icon	Description
RoHS	Compliance with 2011/65/EU
HF	Compliance with IEC61249-2-21:2003
	Mean lead free

Schematic

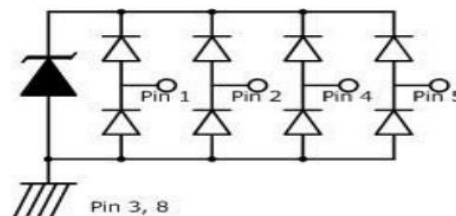

Part Number and Electrical Parameter

Part Number	$I_{DRM}@ V_{DRM}$		$V_{BR}^{(1)}@ I_R$		$V_C@I_{pp}^{(2)}$		$C_o^{(3)}$	$C_o^{(4)}$
	μA	V	V	mA	V	A	pF	pF
	MAX		MIN		MAX		MAX	MAX
BV-FK03U4CD	1	3.3	3.6	1	15	4	0.35	0.65

Absolute maximum ratings measured at $T_A = 25^\circ C$ RH = 45%-75% (unless otherwise noted).

- ① VBR is measured at $I_R = 1mA$, pin1, 2, 4, 5 to pin 3, 8
- ② Surge Waveform: 8/20 μS , pin1,2,4,5 to pin 3,8
- ③ Off-state capacitance is measured in $V_{RMS} = 0.3V$, $f = 1MHz$, IO to IO
- ④ Off-state capacitance is measured in $V_{RMS} = 0.3V$, $f = 1MHz$, IO to GND.

Transient Voltage Suppressor

Part Numbering System

BV FK 03 U 4 C D
(1) (2) (3) (4) (5) (6) (7)

- (1) Bencent Transient Voltage Suppressor
- (2) Package: DFN2510
- (3) Working Voltage:3.3V
- (4) Low Capacitance
- (5) 4 Lines Protection
- (6) Bi-directional,IO to IO
- (7) Bencent internal code

Mark

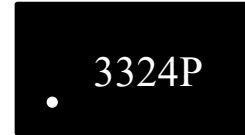

3324P: Part Number

V-I Curve

Parameters	Definition
VC	Clamping voltage
Ipp	Peak pulse current
VDRM	Stand-off Voltage
VBR	Breakdown Voltage
IDRM	Reverse Leakage Current
IR	Test current
VF	Forward on-state voltage
IF	Forward current
Ppp	Peak Pulse Power Dissipation

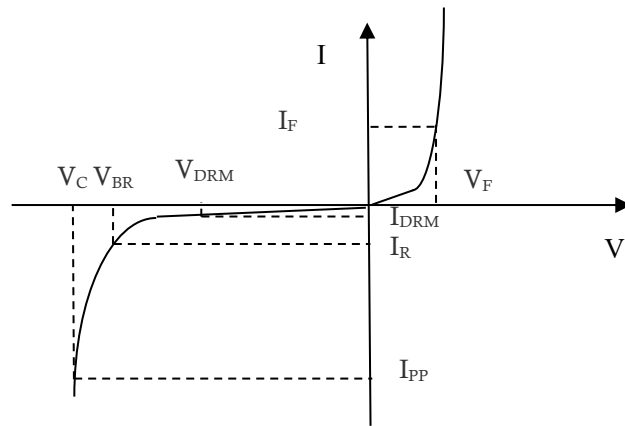

IO to GND

Thermal Consideration

symbol	Parameter	Value	Unit
TJ	Operating Junction Temperature Range	-40 to +125	°C
TS	Storage Temperature Range	-55 to +150	°C

Typical Characteristics

Power Derating Curve

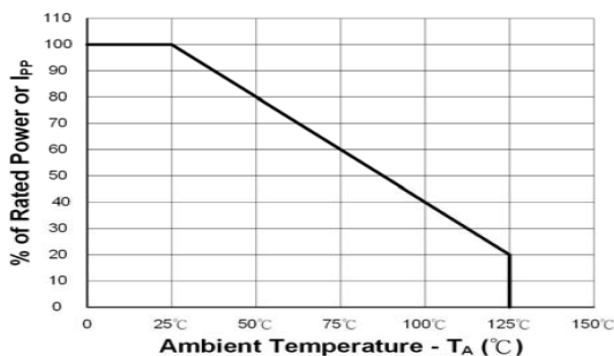

Clamping Voltage Vs. Peak Pulse Current

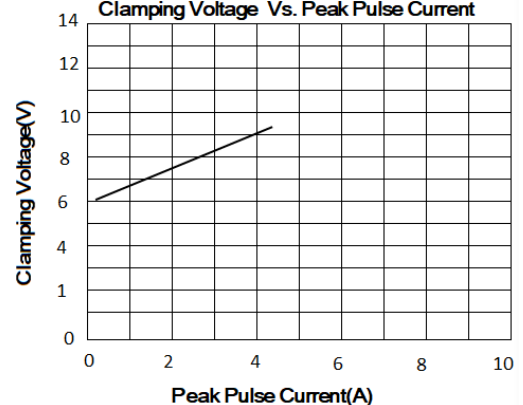

Transient Voltage Suppressor

Version: A0 2021-10-09

Environmental Characteristics

Testing items	Technical standards
High temperature Reverse Bias Test	Temperature: $125\pm 3^{\circ}\text{C}$ Bias= $80\%V_{\text{DRM}}$ Time: 168H
High Temperature Life Test	Temperature: 150°C Time: 168H
High-low Temperature Cycle test	Temperature: From -40°C to 125°C Dwell time: 30min, 10cycles
High Temperature & High Humidity Test	Temperature: 85°C Humidity: 85% Time: 168H
Pressure cooker Test	Temperature: 121°C , 2atm. Humidity: 100% Time: 24H
Resistance of soldering heat	Temperature: $260\pm 5^{\circ}\text{C}$ Time of dip soldering: 10s, 3times

Note: The above testing items can be specified by customer's special request

Product Dimensions

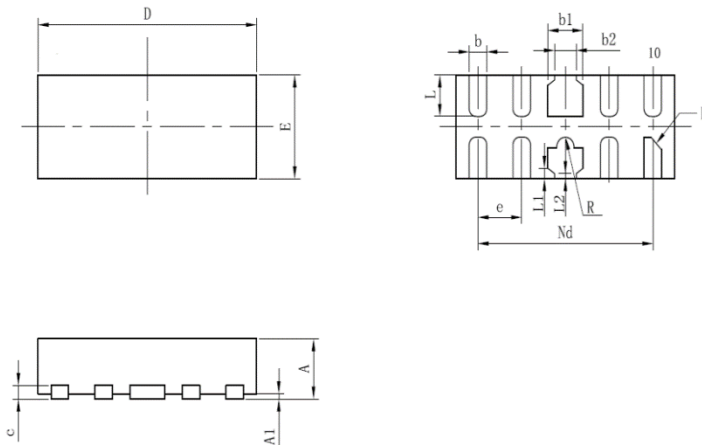

REF	mm	inch
A	0.45~0.55	0.018~0.022
A1	0.00~0.05	0.000~0.002
b	0.15~0.25	0.006~0.01
b1	0.35~0.45	0.014~0.018
b2	0.2~0.3	0.008~0.012
c	0.1~0.2	0.004~0.008
D	2.45~2.55	0.096~0.100
e	0.50BSC	0.020BSC
Nd	2.00BSC	0.079BSC
E	0.95~1.05	0.037~0.041
L	0.35~0.45	0.014~0.018
L1	0.075REF	0.003REF
L2	0.05REF	0.002REF
h	0.08~0.15	0.003~0.006
R	0.05~0.15	0.002~0.006

Recommended Soldering Pad

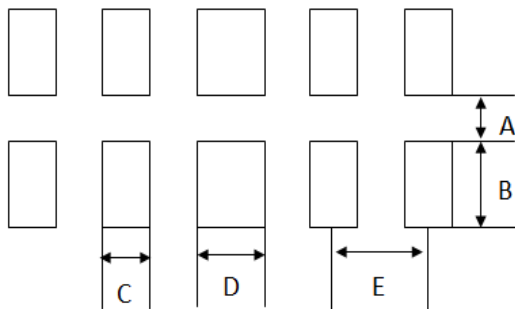

REF	mm	inch
A	0.2	0.008
B	0.6	0.024
C	0.3	0.012
D	0.45	0.018
E	0.5	0.020

Transient Voltage Suppressor

Version: A0 2021-10-09

Reflow Profile

Reflow Condition		Pb-Free assembly
Pre Heat	Temperature Min	150°C
	Temperature Max	200°C
	Time (min to max)	60 – 180 secs
Average ramp up rate (Liquid) Tamp (T _L) to peal		3°C/s max
T _S (max) to T _L - Ramp-up Rate		3°C/s max
Reflow	- Temperature (T _L) (Liquid)	217°C
	- Temperature (T _L)	60 – 150 secs
Peak Temperature (T _P)		260±0/-5 °C
Time within 5°C of actual peak Temperature (T _P)		25secs
Ramp-down Rate		6°C/s max
Time 25°C to peak Temperature (T _P)		8 mins Max.
Do not exceed		260°C

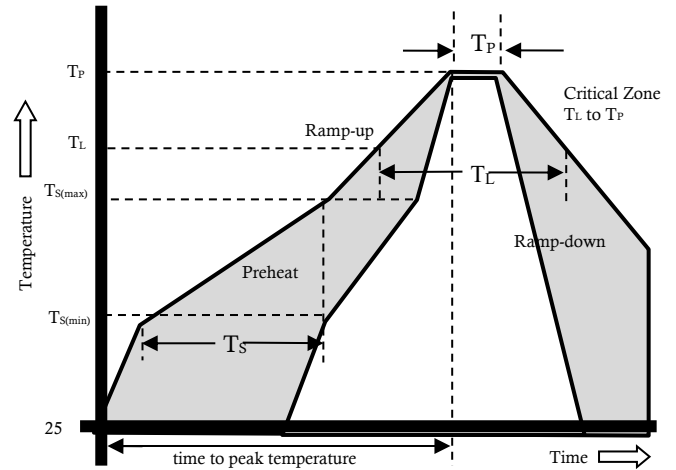

Package Reel Information

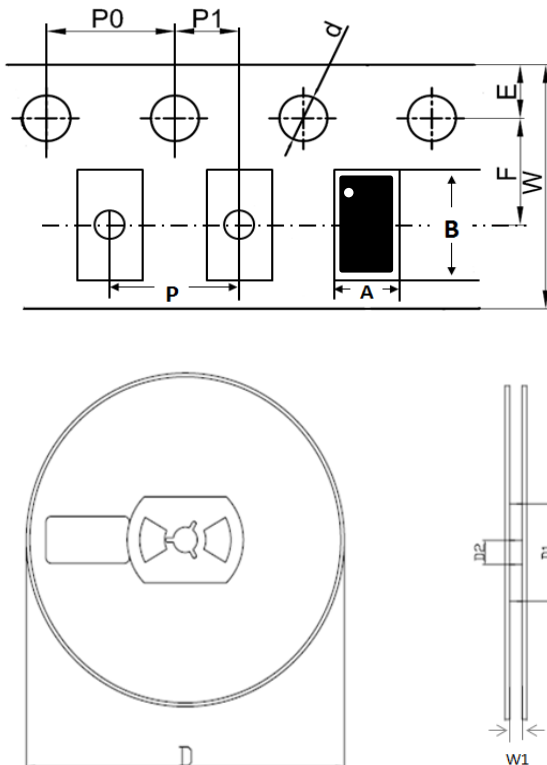

REF	mm	inch
A	1.2+/-0.10	0.047+/-0.004
B	2.7+/-0.10	0.106+/-0.004
d	1.50+0.1/-0	0.059+0.004/-0
D	178.00+/-2.00	7.008+/-0.079
D1	55.00+/-3.00	2.165+/-0.118
D2	13.00+/-0.50	0.512+/-0.020
E	1.75+/-0.10	0.069+/-0.004
F	3.50+/-0.20	0.138+/-0.008
P	4.00+/-0.20	0.157+/-0.008
P0	4.00+/-0.20	0.157+/-0.008
P1	2.00+/-0.20	0.079+/-0.008
W	8.00+/-0.20	0.315+/-0.008
W1	9.50+/-1.00	0.374+/-0.039

Outline	Reel (pcs)	Per Carton (pcs)	Reel Diameters (mm)	Carton Size(mm)		
				L	W	H
Taping	3,000	90,000	178	390	370	220