

|                            |                |                        |             |
|----------------------------|----------------|------------------------|-------------|
| DOCUMENT No.<br>SRBD-S-002 | TITLE<br>製品仕様書 | PRODUCT SPECIFICATIONS | PAGE<br>1/4 |
| BACKGROUND                 |                |                        | ⑤           |

1. General 一般事項

1.1 Application 適用範囲 This specification is applied to low current circuit (Secondary circuit) rotary switch used for electronic equipment. この仕様書は主として電子機器に用いる低電流回路用(2次側回路用)ロータリスイッチに適用する。

1.2 Operating temperature range 使用温度範囲: -25 ~ 85°C

1.3 Storage temperature range 保存温度範囲: -40 ~ 60°C

1.4 Test conditions 試験状態 Unless otherwise specified, the atmospheric conditions for making measurements and tests are as follows. 試験及び測定は特に規定がない限り以下の標準状態のもとで行う。  
 Ambient temperature 温度: 5~35°C  
 Relative humidity 相対湿度: 25~85%  
 Air pressure 気圧: 86~106kPa  
 Should any doubt arise in judgement, tests shall be conducted at the following conditions. ただし、判定に疑義を生じた場合は以下の標準状態で行う。  
 Ambient temperature 温度: 20±2°C  
 Relative humidity 相対湿度: 60~70%  
 Air pressure 気圧: 86~106kPa

2. Appearance, construction and dimensions 外観、構造、寸法

2.1 Appearance 外観 Switch shall have good finishing, and no rust, crack or plating failures. 各部の仕上げは良好で、機能上有害な錆、傷、割れ、めっき不良及び剥離等があるてはならない。

2.2 Construction and dimensions 構造、寸法 Refer to individual product drawing. 個別製品図による。

3. Rating 定格 Maximum 最大 5 V DC 1 mA (Resistive load)(抵抗負荷)  
Minimum 最小 3 V DC 50 μA (Resistive load)(抵抗負荷)

4. Electrical specification 電気的性能

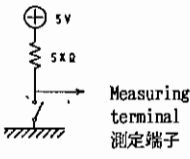
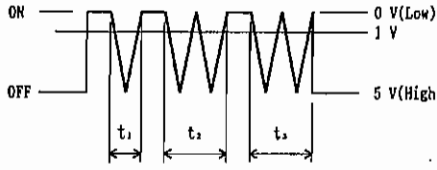
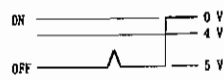
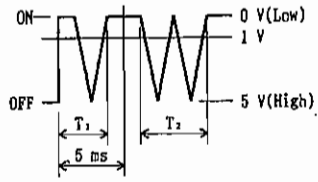
| Items 項目  | Test conditions 試験条件  | Criteria 判定基準  |
|---|---|--|
| 4.1 Contact resistance 接触抵抗(1)                        | Shall be measured at 1 kHz±200 Hz (20 mV MAX, 50 mA MAX).<br>1 kHz±200 Hz、電圧 20 mV 以下、電流 50 mA 以下による方法で測定する。  | 200 mΩ MAX   |
| Contact resistance 接触抵抗(2)                            | 50 mA, 15 V DC by four terminal method.<br>DC 15V, 50mA の4端子法で測定する。   | 70 mΩ MAX  |
| 4.2 Insulation resistance 絶縁抵抗                        | Test voltage: 100 V DC, measured after 1 min ± 5 s<br>Applied position: Between all terminals<br>Between terminals and ground(frame)<br>DC 100 V の電圧を 1分±5秒間端子相互間、端子フレーム間に印加し、測定する。   | 100 MΩ MIN   |
| 4.3 Voltage proof 耐電圧                                 | Test voltage: 100 V AC (50~60Hz, cut-off current 2 mA)<br>Duration: 1 min<br>Applied position: Between all terminals<br>Between terminals and ground(frame)<br>AC 100 V (50~60Hz、感度電流 2 mA) の電圧を 1分間端子相互間、端子フレーム間に印加する。   | No dielectric breakdown shall occur.<br>絶縁破壊のないこと。   |
| 4.4 Changeover timing 切換タイミング                         |   | Refer to individual product drawing.<br>個別製品図による。  |
| 4.4 Contact chattering and bounce チャタリング 振動ノイズ (バウンス) | Shall be measured at the operation speed of 1~1.2πrad/s and 1 mA, 5 V DC. (Resistive load)<br>DC 5 V, 1 mA(抵抗負荷)、動作速度1~1.2πrad/sにて測定する。<br><br>[Measuring circuit] 測定回路<br><br><br><br><br>Resolution of measurement 測定の分解能: 200 μs<br>Noise voltage at the range of OFF code: 4 V MIN<br> | T <sub>1</sub> , T <sub>2</sub> and T <sub>3</sub> shall be defined the voltage fluctuation time exceeding 1 V.<br>Contact chattering T <sub>1</sub> , T <sub>3</sub> : 8 ms MAX<br>Contact bounce T <sub>2</sub> : 3 ms MAX<br>When 250 μs interval less than 1 V exists between each bounce, it shall be measured individually.<br>T <sub>1</sub> , T <sub>2</sub> , T <sub>3</sub> は 1 V以上の電圧変動時間とする。<br>チャタリング T <sub>1</sub> , T <sub>3</sub> : 8 ms MAX<br>振動ノイズ(バウンス) T <sub>2</sub> : 3 ms MAX<br>振動ノイズ間に 1 V以下の範囲が250 μs以上ある場合は、別の振動ノイズとする。<br><br>When the voltage is less than 1 V at the point after 8 ms from the point of OFF→ON or ON→OFF, subsequent voltage fluctuation exceeding 1 V shall be measured as T <sub>2</sub> .<br>コードのOFF→ON及びON→OFFのポイントより 8ms の時点で 1 V 以下の場合、その後の 1 V 以上の電圧変動部分は振動ノイズ T <sub>2</sub> として測定する。<br> |

|      |      |            |      |      |      |      |      |      |            |      |      |      |      |                        |                        |                        |
|------|------|------------|------|------|------|------|------|------|------------|------|------|------|------|------------------------|------------------------|------------------------|
|      |      |            |      |      |      |      |      |      |            |      |      |      |      | APPD.<br>Jan. 26, 2006 | CHKD.<br>Jan. 26, 2006 | DSGD.<br>Jan. 26, 2006 |
| PAGE | SYMB | BACKGROUND | DATE | APPD | CHKD | DSGD | PAGE | SYMB | BACKGROUND | DATE | APPD | CHKD | DSGD | Y. TANABE              | T. KAWASE              | Y. SASAKI              |



| DOCUMENT No.                        | TITLE  | PRODUCT SPECIFICATIONS  | PAGE |
|-------------------------------------|--|---|------|
| SREB-S-002                          |  | 變壓器 部品 仕様 仕様 仕様   | 2/4  |
| 5. Mechanical specification 機械的性能   |  |   |      |
| Items 項目                            | Test conditions 試験条件   | Criteria 判定基準   |      |
| 5.1 Rotational torque<br>回転トルク      | Refer to item 5.8.<br>5.8項による。   | Initial 初期: $13 \pm 5 \text{ mN}\cdot\text{m}$<br>After re-flow soldering リフロー後: $12 \pm 5 \text{ mN}\cdot\text{m}$   |      |
| 5.2 Changeover angle<br>切換角度        |  | Refer to individual product drawing.<br>個別製品図による。   |      |
| 5.3 Robustness of terminal<br>端子強度  | A static load of $3 \text{ N}$ shall be applied to the tip of terminal in a desired direction for 1 min. The test shall be done once per terminal.<br>端子先端の一方へ $3 \text{ N}$ の静荷重を1分間加える。<br>ただし、回数は1端子当たり1回とする。   | Shall be free from terminal looseness, damage and breakage of terminal holding portion. Terminals may be bent after test. Electrical performance requirement specified in item 4 shall be satisfied.<br>端子の脱落、破損及び端子保持部の破損のないこと。ただし、端子の曲がりは差し支えないものとする。また、試験後 4項の電気的性能を満足すること。  |      |
| 5.4 Robustness of actuator<br>操作部強度 | A static load of $50 \text{ N}$ shall be applied to the vertical direction of the shaft for 15 s.<br>操作部と垂直方向に $50 \text{ N}$ の静荷重を15秒間加える。<br><br>A static load of $20 \text{ N}$ shall be applied to the pulling direction of the shaft for 15 s.<br>操作部の引張り方向に $20 \text{ N}$ の静荷重を15秒間加える。   | Shall be free from pronounced wobble, deformation and mechanical abnormalities.<br>著しいガタ及び曲がりのないこと。<br>また、機械的に異常のないこと。  |      |
| 5.5 Vibration<br>耐振性                | Switch shall be secured to a testing machine by a normal mounting device and method. Switch shall be measured after following test.<br>スイッチを正規の取付用具、取付方法で試験機に固定し、下記条件で試験を行い、試験後測定する。<br>(1)Vibration frequency range 振動数範囲: 10~55 Hz<br>(2)Total amplitude 全振幅: 1.5 mm<br>(3)Sweep ratio 掃引の割合: 10-55-10 Hz Approx. 1 min 約1分<br>(4)Method of changing the sweep vibration frequency: Logarithmic or linear 掃引振動数の変化方法 対数又は直線近似<br>(5)Direction of vibration: Three perpendicular directions including actuator 振動の方向 操作部を含む垂直3方向<br>(6)Duration 振動時間: 2 h each (6 h in total) 各 2時間 (計 6時間)   | Contact resistance 接触抵抗 (Item 4.1-1): $250 \text{ m}\Omega \text{ MAX}$<br>Insulation resistance 絶縁抵抗 (Item 4.2): $100 \text{ M}\Omega \text{ MIN}$<br>Voltage proof 耐電圧 (Item 4.3):<br>Apply $100 \text{ V AC}$ for 1 min.<br>No dielectric breakdown shall occur.<br>絶縁破壊のないこと。<br>Rotational torque 回転トルク (Item 5.1):<br>Within specified value.<br>規格値内とする。<br>Shall be free from mechanical abnormalities.<br>機械的に異常がないこと。 |      |
| 5.6 Shock<br>耐衝撃性                   | Switch shall be measured after following test.<br>下記条件で試験を行い、試験後測定する。<br>(1)Mounting method 取付方法: Normal mounting method 正規の方法で取り付ける。<br>(2)Acceleration 加速度: $490 \text{ m/s}^2 \{ 50 \text{ G} \}$<br>(3)Duration 作用時間: 11 ms<br>(4)Test direction 試験方向: 6 directions 6面<br>(5)Number of shocks 試験回数: 3 times per direction (18 times in total) 各方向各3回 (計18回)  | Contact resistance 接触抵抗 (Item 4.1-1): $250 \text{ m}\Omega \text{ MAX}$<br>Insulation resistance 絶縁抵抗 (Item 4.2): $100 \text{ M}\Omega \text{ MIN}$<br>Voltage proof 耐電圧 (Item 4.3):<br>Apply $100 \text{ V AC}$ for 1 min.<br>No dielectric breakdown shall occur.<br>絶縁破壊のないこと。<br>Rotational torque 回転トルク (Item 5.1):<br>Within specified value.<br>規格値内とする。<br>Shall be free from mechanical abnormalities.<br>機械的に異常がないこと。 |      |
| 5.7 Solderability<br>はんだ付け性         | Switch shall be checked after following test.<br>下記条件で試験を行い、試験後確認する。<br>(1)Solder はんだ: Sn/3.0Ag/0.5Cu<br>(2)Flux フラックス: Rosin flux having a nominal composition of 25% solids by mass of water white rosin in 2-propanol solution.<br>ロジンの2-プロパノール溶液とし、濃度は質量比ロジン約25%とする。<br>(3)Preprocessing 前処理<br>High temperature keeping 高温保管: $150^\circ\text{C}$ 1h<br>PCT: $105^\circ\text{C}$ 100% $1.22 \times 10^5 \text{ Pa}$ 4h<br>It applies to the terminal Part.<br>端子部分に適用。<br>(3)Soldering temperature はんだ温度: $240 \pm 2^\circ\text{C}$<br>Immersing time 浸漬時間: 3s<br>Flux immersing time shall be 3~5 s in normal room temperature.<br>ただし、フラックス浸漬は常温で3~5秒とする。<br>(4)Immersion depth: Immersion depth shall be at copper plating portion for P.C.B. terminal after mounting.<br>浸漬深さ<br>Thickness of P.C.B.: 1.6 mm<br>Immersion depth shall be at wiring portion of lead wire for lead wire terminal.<br>プリント基板用端子はプリント基板(t1.6)実装後、銅箔面まで浸漬。リード配線用端子は端子のリード線からげ部を浸漬。 | More than 95% of immersed part shall be covered with solder.<br>If frame is made of tin-plate, cutting section shall not be applied.<br>浸漬した部分の 95% 以上がはんだで覆われていること。<br>ただし、ふりき棒の場合は、破断面は適用しない。   |      |

|                            |  |             |
|----------------------------|--|-------------|
| DOCUMENT No.<br>SRBD-S-002 | TITLE<br>PRODUCT SPECIFICATIONS<br>製品仕様書 | PAGE<br>3/4 |
|----------------------------|--|-------------|

| Items 項目                                      | Test conditions 試験条件   | Criteria 判定基準  |         |        |        |        |        |        |        |             |     |     |     |     |     |     |             |     |     |     |     |     |     |        |     |     |     |     |     |     |        |     |     |     |     |     |     |                 |      |  |  |  |  |  |
|---|--|--|---------|--------|--------|--------|--------|--------|--------|-------------|-----|-----|-----|-----|-----|-----|-------------|-----|-----|-----|-----|-----|-----|--------|-----|-----|-----|-----|-----|-----|--------|-----|-----|-----|-----|-----|-----|-----------------|------|--|--|--|--|--|
| 5.8<br>Resistance to soldering heat<br>はんだ耐熱性 | <p>Switch shall be measured after following test.<br/>下記条件で試験を行い、試験後確認する。<br/>Profile of Lead-Free Solder Reflow Temperature 鉛フリー対応リフロー温度プロファイル<br/>Surface of product<br/>Temperature(°C)<br/>部品表面温度</p> <p>Above conditions shall be applied to Glass fabric base,epoxy resin P.C.B of 0.8 mm thick.Soldering iron shall be put at the tip of terminals and prevented excessive force to the terminals.<br/>上記の条件は、t0.8 mm のガラス基材エポキシ樹脂積層板について適用する。<br/>また、はんだごては端子先端に当て、端子に異常加圧のないこと。</p> | <p>No abnormalities shall be observed in appearance and operation. The electrical performance requirements specified in item 4 shall be satisfied.<br/>外観に著しい変形のないこと。<br/>また、動作に異常がなく、4項の電氣的性能を満足すること。</p> <p>Rotational torque 回転トルク(Item 5.1):<br/><u>12 ± 5</u> mN·m</p> <p>*リフロー槽:タムラ製 TAR30-366PN<br/>設定条件:下表による。</p> <table border="1"> <thead> <tr> <th>装置設定基準値</th> <th>Zone 1</th> <th>Zone 2</th> <th>Zone 3</th> <th>Zone 4</th> <th>Zone 5</th> <th>Zone 6</th> </tr> </thead> <tbody> <tr> <td>ヒーター上設定(°C)</td> <td>165</td> <td>170</td> <td>170</td> <td>175</td> <td>190</td> <td>277</td> </tr> <tr> <td>ヒーター下設定(°C)</td> <td>165</td> <td>170</td> <td>170</td> <td>175</td> <td>190</td> <td>277</td> </tr> <tr> <td>パワー上設定</td> <td>Mid</td> <td>Mid</td> <td>Mid</td> <td>Mid</td> <td>Mid</td> <td>Mid</td> </tr> <tr> <td>パワー下設定</td> <td>Mid</td> <td>Mid</td> <td>Mid</td> <td>Mid</td> <td>Mid</td> <td>Mid</td> </tr> <tr> <td>コンベアスピード(m/min)</td> <td colspan="6">0.82</td> </tr> </tbody> </table> | 装置設定基準値 | Zone 1 | Zone 2 | Zone 3 | Zone 4 | Zone 5 | Zone 6 | ヒーター上設定(°C) | 165 | 170 | 170 | 175 | 190 | 277 | ヒーター下設定(°C) | 165 | 170 | 170 | 175 | 190 | 277 | パワー上設定 | Mid | Mid | Mid | Mid | Mid | Mid | パワー下設定 | Mid | Mid | Mid | Mid | Mid | Mid | コンベアスピード(m/min) | 0.82 |  |  |  |  |  |
| 装置設定基準値                                       | Zone 1   | Zone 2   | Zone 3  | Zone 4 | Zone 5 | Zone 6 |        |        |        |             |     |     |     |     |     |     |             |     |     |     |     |     |     |        |     |     |     |     |     |     |        |     |     |     |     |     |     |                 |      |  |  |  |  |  |
| ヒーター上設定(°C)                                   | 165  | 170  | 170     | 175    | 190    | 277    |        |        |        |             |     |     |     |     |     |     |             |     |     |     |     |     |     |        |     |     |     |     |     |     |        |     |     |     |     |     |     |                 |      |  |  |  |  |  |
| ヒーター下設定(°C)                                   | 165  | 170  | 170     | 175    | 190    | 277    |        |        |        |             |     |     |     |     |     |     |             |     |     |     |     |     |     |        |     |     |     |     |     |     |        |     |     |     |     |     |     |                 |      |  |  |  |  |  |
| パワー上設定  | Mid  | Mid  | Mid     | Mid    | Mid    | Mid    |        |        |        |             |     |     |     |     |     |     |             |     |     |     |     |     |     |        |     |     |     |     |     |     |        |     |     |     |     |     |     |                 |      |  |  |  |  |  |
| パワー下設定  | Mid  | Mid  | Mid     | Mid    | Mid    | Mid    |        |        |        |             |     |     |     |     |     |     |             |     |     |     |     |     |     |        |     |     |     |     |     |     |        |     |     |     |     |     |     |                 |      |  |  |  |  |  |
| コンベアスピード(m/min)                               | 0.82   |  |         |        |        |        |        |        |        |             |     |     |     |     |     |     |             |     |     |     |     |     |     |        |     |     |     |     |     |     |        |     |     |     |     |     |     |                 |      |  |  |  |  |  |

6.Durability 耐久性能

|   |  |   |
|---|--|---|
| 6.1<br>Operating life without load<br>無負荷寿命 | <p>10,000 cycles of operation shall be performed continuously at a rate of 1~1.2π rad/s without load.<br/>無負荷にて10,000サイクル(動作速度1~1.2π rad/s)連続動作を行う。</p>  | <p>Contact resistance 接触抵抗 (Item 4.1-1):<br/><u>250</u> mΩ MAX<br/>Insulation resistance 絶縁抵抗(Item 4.2):<br/><u>100</u> MΩ MIN<br/>Voltage proof 耐電圧 (Item 4.3):<br/>Apply <u>100</u> V AC for 1 min.<br/>No dielectric breakdown shall occur.<br/>絶縁破壊のないこと。<br/>Rotational torque 回転トルク (Item 5.1):<br/>Within<u>±0,-15%</u> of specified value.<br/>規格値の<u>±0,-15%</u> 以内。<br/>No abnormalities shall be recognized in appearance and construction.<br/>外観、構造に異常がないこと。</p> |
| 6.2<br>Operating life with load<br>負荷寿命     | <p>10,000 cycles of operation shall be performed continuously at a rate of 1~1.2π rad/s with load of <u>1</u> mA, <u>3</u> V DC.<br/>DC <u>3</u> V, <u>1</u> mA(抵抗負荷)にて10,000サイクル(動作速度 1~1.2π rad/s)連続動作を行う。</p> | <p>Contact resistance 接触抵抗 (Item 4.1-1):<br/><u>250</u> mΩ MAX<br/>Insulation resistance 絶縁抵抗(Item 4.2):<br/><u>100</u> MΩ MIN<br/>Voltage proof 耐電圧 (Item 4.3):<br/>Apply <u>100</u> V AC for 1 min.<br/>No dielectric breakdown shall occur.<br/>絶縁破壊のないこと。<br/>Rotational torque 回転トルク (Item 5.1):<br/>Within<u>±0,-15%</u> of specified value.<br/>規格値の<u>±0,-15%</u> 以内。<br/>No abnormalities shall be recognized in appearance and construction.<br/>外観、構造に異常がないこと。</p> |

7.Environmental test 耐候性

| Items 項目           | Test conditions 試験条件   | Criteria 判定基準   |
|--------------------|--|---|
| 7.1<br>Cold<br>耐寒性 | <p>After testing at -40±2°C for 500 h, the switch shall be allowed to stand under normal room temperature and humidity conditions for 1 h, and then measurement shall be made within 1 h. Water drops shall be removed.<br/>-40±2°Cにて500時間試験後、常温常湿中に1時間放置し1時間以内に測定する。<br/>ただし、水滴は取り除く。</p> | <p>Contact resistance 接触抵抗 (Item 4.1-1):<br/><u>250</u> mΩ MAX<br/>Insulation resistance 絶縁抵抗(Item 4.2):<br/><u>100</u> MΩ MIN<br/>Voltage proof 耐電圧 (Item 4.3):<br/>Apply <u>100</u> V AC for 1 min.<br/>No dielectric breakdown shall occur.<br/>絶縁破壊のないこと。<br/>Rotational torque 回転トルク (Item 5.1):<br/>Within<u>±10,-30%</u> of specified value.<br/>規格値の<u>±10,-30%</u> 以内。<br/>No abnormalities shall be recognized in appearance and construction.<br/>外観、構造に異常がないこと。</p> |

| DOCUMENT No.                             | TITLE  | PRODUCT SPECIFICATIONS   | PAGE |
|--|--|--|------|
| SRBD-S-002                               |  | 製品仕様書  | 4/4  |
| Items 項目                                 | Test conditions 試験条件   | Criteria 判定基準  |      |
| 7.2 Dry heat<br>耐熱性                      | After testing at 85±2°C for 500 h, the switch shall be allowed to stand under normal room temperature and humidity conditions for 1 h, and then measurement shall be made within 1 h.<br>85±2°Cにて500時間試験後、常温常湿中に1時間放置し1時間以内に測定する。  | Contact resistance 接触抵抗 (Item 4.1-1) :<br>250 mΩ MAX<br>Insulation resistance 絶縁抵抗 (Item 4.2) :<br>100 MΩ MIN<br>Voltage proof 耐電圧 (Item 4.3) :<br>Apply 100 V AC for 1 min.<br>No dielectric breakdown shall occur.<br>絶縁破壊のないこと。<br>Rotational torque 回転トルク (Item 5.1) :<br>Within+10,-30% of specified value.<br>規格値の+10,-30% 以内。<br>No abnormalities shall be recognized in appearance and construction.<br>外観、構造に異常がないこと。 |      |
| 7.3 Damp heat<br>耐湿性                     | After testing at 60±2°C and 90~95%RH for 500 h, the switch shall be allowed to stand under normal room temperature and humidity conditions for 1 h, and then measurement shall be made within 1 h. Water drops shall be removed.<br>60±2°C、相対湿度90~95%にて500時間試験後、常温常湿中に1時間放置し1時間以内に測定する。ただし、水滴は取り除く。  | Contact resistance 接触抵抗 (Item 4.1-1) :<br>250 mΩ MAX<br>Insulation resistance 絶縁抵抗 (Item 4.2) :<br>10 MΩ MIN<br>Voltage proof 耐電圧 (Item 4.3) :<br>Apply 100 V AC for 1 min.<br>No dielectric breakdown shall occur.<br>絶縁破壊のないこと。<br>Rotational torque 回転トルク (Item 5.1) :<br>Within+10,-30% of specified value.<br>規格値の+10,-30% 以内。<br>No abnormalities shall be recognized in appearance and construction.<br>外観、構造に異常がないこと。  |      |
| 7.4 Change of Temperature<br>温度サイクル      | After 10 cycles of following conditions, the switch shall be allowed to stand under normal room temperature and humidity conditions for 1 h, and measurement shall be made within 1 h after that. Water drops shall be removed.<br>下記条件で10サイクル試験後、常温常湿中に1時間放置し1時間以内に測定する。ただし、水滴は取り除く。<br><br>  | Contact resistance 接触抵抗 (Item 4.1-1) :<br>250 mΩ MAX<br>Insulation resistance 絶縁抵抗 (Item 4.2) :<br>100 MΩ MIN<br>Voltage proof 耐電圧 (Item 4.3) :<br>Apply 100 V AC for 1 min.<br>No dielectric breakdown shall occur.<br>絶縁破壊のないこと。<br>Rotational torque 回転トルク (Item 5.1) :<br>Within+10,-30% of specified value.<br>規格値の+10,-30% 以内。<br>No abnormalities shall be recognized in appearance and construction.<br>外観、構造に異常がないこと。 |      |
| 7.5 Resistance to Sulfuration<br>耐硫化水素ガス | After following testing, the switch shall be allowed to stand under normal room temperature and humidity conditions for 1 h, and then measurement shall be made within 1 h.<br>下記条件で試験後、常温常湿中に1時間放置し、1時間以内に測定する。<br>Temperature 温度: 40±2 °C<br>Humidity 湿度: 75±5 % RH<br>Density 濃度: H <sub>2</sub> S gas 1±0.2 ppm<br>Duration 試験時間: 96±1 h | Contact resistance 接触抵抗 (Item 4.1-1) :<br>1 Ω MAX<br>No abnormalities shall be recognized in appearance and construction.<br>外観、構造に異常がないこと。  |      |

## Precaution in use ご使用上の注意

- Note that if the load is applied to the terminals during soldering they might suffer deformation and defects in electrical performance.  
端子をはんだ付けされる場合、端子に荷重が加わりますと条件によりガタ、変形及び電気的特性劣化のおそれがありますのでご注意ください。
- Use of water-soluble soldering flux shall be avoided because it may cause corrosion of the switch.  
はんだ付けの際、水溶性フラックスはスイッチを腐食させるおそれがありますので使用はお避け下さい。

CORRESPONDENCE TABLE OF POSITION NO. AND TERMINAL NO. (タンシノ. とポジションノ. との対応表)

| POSITION NO. | TERMINAL NO. | DETENT |
|--------------|--------------|--------|
| 1            | ③            | -      |
| 2            | ④            | ○      |
| 3            | ⑤            | ○      |
| 4            | ⑥            | ○      |
| 5            | ⑦            | ○      |
| 6            | ⑧            | ○      |
| 7            | ⑨            | ○      |
| 8            | ⑩            | ○      |
| 9            | ⑪            | ○      |
| 10           | ⑫            | -      |

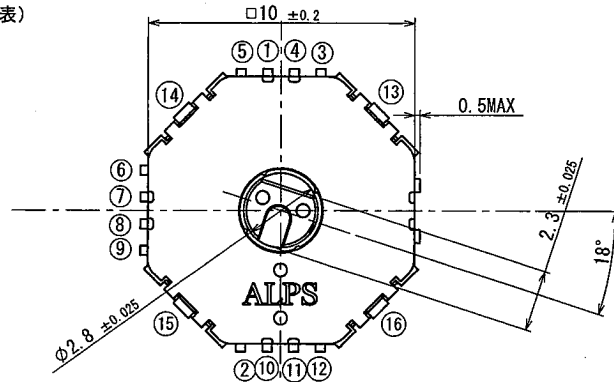

REEL (リール)

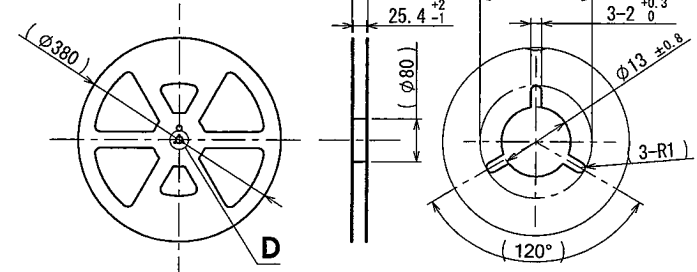

CARRIER TAPE (キャリアテープ)

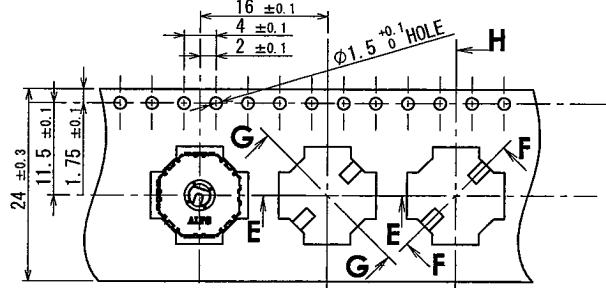

DETAIL OF D

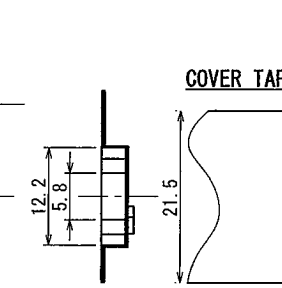

COVER TAPE (カバーテープ)

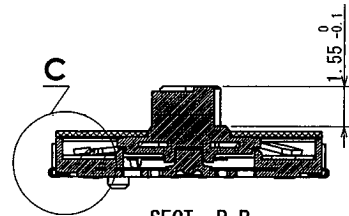
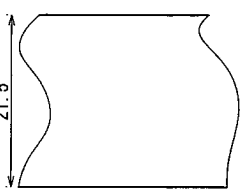

SECT. B-B

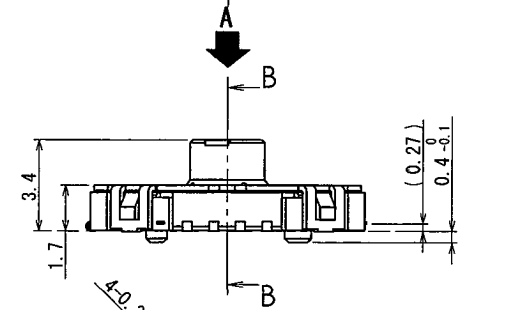

A

B

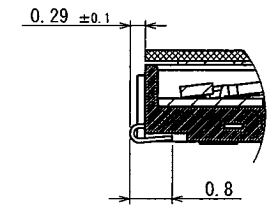

DETAIL OF C

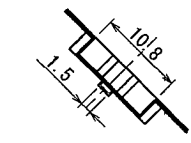
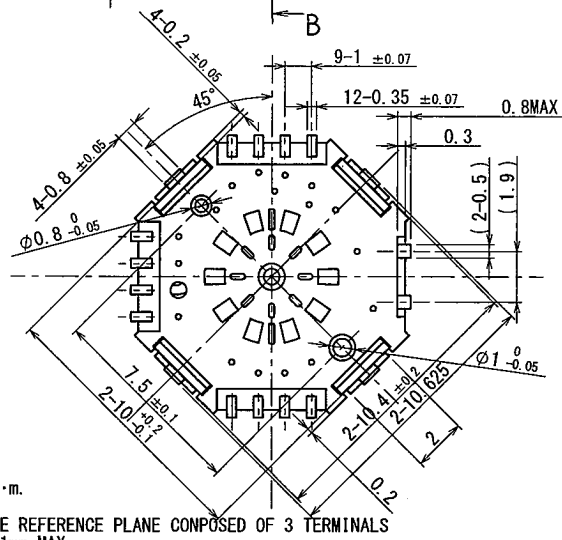

SECT. G-G

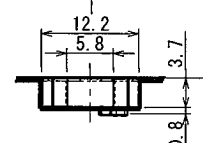

SECT. E-E

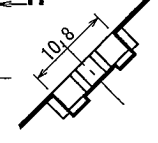

SECT. F-F

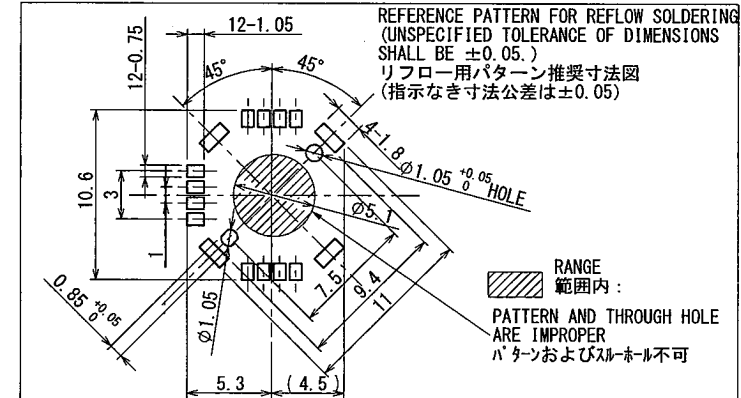

REFERENCE PATTERN FOR REFLOW SOLDERING  
(UNSPECIFIED TOLERANCE OF DIMENSIONS SHALL BE ±0.05.)  
リフロー用パターン推奨寸法図  
(指示なき寸法公差は±0.05)

RANGE 範囲内:  
PATTERN AND THROUGH HOLE ARE IMPROPER  
パターンおよびスルーホール不可

CIRCUIT DIAGRAM (VIEW IN DIRECTION OF ARROW A)

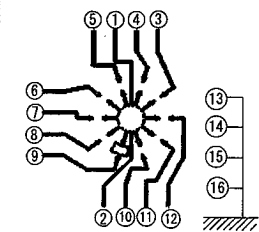

TERMINAL ①②: COMMON TERMINAL

- TAPING SPECIFICATION SHALL BE IN ACCORDANCE WITH TAPE-S-028. (テープの仕様はTAPE-S-028テープ仕様による.)
- NUMBER OF DETENTS: 8 (クリック数: 8)
- ROTATIONAL TORQUE SHALL BE 13 ± 5mN·m. (回転トルクは13 ± 5mN·m.)
- COPLANARITY OF 12 TERMINALS (TO THE REFERENCE PLANE COMPOSED OF 3 TERMINALS OF TERMINAL NO. 13~16) SHALL BE 0.1mm MAX. (タッ12本のコプラナリティーは、タンシ⑬~⑯のいずれか3点で構成される基準面に対し、0.1以下とする.)
- CHANGEOVER TIMING: NON SHORTING. (切換タイミングはノンショーティング.)
- DRAWING SHOWS THE POSITION IN SHIPPING. (図面は出荷位置を示す.)
- NUMBER OF POSITIONS: 10 (ポジション数は10)
- CHANGEOVER ANGLE: 36° (ENDLESS) (切換角度は36° (エンドレス) .)

| TOLERANCE UNLESS OTHERWISE SPEC. |           | SYMB | DATE | APPD | CHKD | DSGD |
|----------------------------------|-----------|------|------|------|------|------|
| BASIC DIMENSION                  | TOLERANCE |      |      |      |      |      |
| UP TO 4                          | ±0.2      |      |      |      |      |      |
| ABOVE 4 TO 16                    | ±0.3      |      |      |      |      |      |
| ABOVE 16 TO 63                   | ±0.4      |      |      |      |      |      |
| ABOVE 63 TO 250                  | ±0.5      |      |      |      |      |      |
| ABOVE 250                        | ±0.7      |      |      |      |      |      |
| ANGULAR DIMENSION                | ±3°       |      |      |      |      |      |

ALPS ELECTRIC CO., LTD.

|                   |       |                      |
|-------------------|-------|----------------------|
| DSGD, Dec.02,2010 | SCALE | NO.                  |
| S.SASAKI          |       | SRBD180201           |
| CHKD, Dec.02,2010 | UNIT  | TITLE                |
| F.YASUDA          |       | PRODUCT DRAWING(1/1) |
| APPD, Dec.02,2010 | mm    | DOCUMENT NO.         |
| F.YASUDA          |       |                      |